



Vision+ N3 30X

User Manual



V1.0



CONTENT



CONTENT	1
SAFETY GUIDES	2
USE CHECK	4
PRODUCT HIGHLIGHTS	6
CAMERA SPEC	7
INTERFACE DESCRIPTION	9
CAMERA DIMENSION	10
INSTALLATION	11
IR REMOTE CONTROLLER	13
VISCA IN(RS232 PORT)	15
VISCA PROTOCOL	17
PELCO-D PROTOCOL	30
PELCO-P PROTOCOL	31
OSD MENU	32
UVC CONTROL	36
WEB SETTING	37
VIEW RTSP VIDEO VIA VLC	45
NDI TOOLS	46
VISCA OVER IP	48

== SAFETY GUIDES ==

- Before operation, please fully read and follow all instructions in the manual. For your safety, always keep this manual with the camera.
- The camera power voltage is 12V DC, rated current is 2A. We suggest you use it with the original power supply adapter supplied by the factory.
- Please keep the power cable, video cable and control cable in a safe place. Protect all cables especially the connectors.
- Operational environment: $-10^{\circ}\text{C}\sim 50^{\circ}\text{C}$, humidity less than 80%.
- To avoid any danger, please keep the camera away from the corrosive liquid.
- Avoid stress, vibration and damp during transportation, storage and installation.
- Do not remove the camera housing and cover. For any service, please contact authorized technicians.
- Video cable and control cable should be individually shielded, and cannot be substituted with other cables. Do not direct the camera lens towards strong light, such as the sun or the intensive light.
- Use a dry and soft cloth to clean the camera housing. Applied with neutral cleaning agent when there is need to clean. To avoid damage on the camera lens, never use strong or abrasive cleaning agents on the camera housing.
- Do not move the camera by holding the camera head. To avoid mechanical trouble, do not rotate the camera head by hand.
- Put the camera on fixed and smooth desk or platform, avoid leaned installation.
- Power Supply Polarity:



■■■■ SAFETY GUIDES ■■■■

Attention !

▲ The video quality may be affected by the specific frequencies of electromagnetic field.

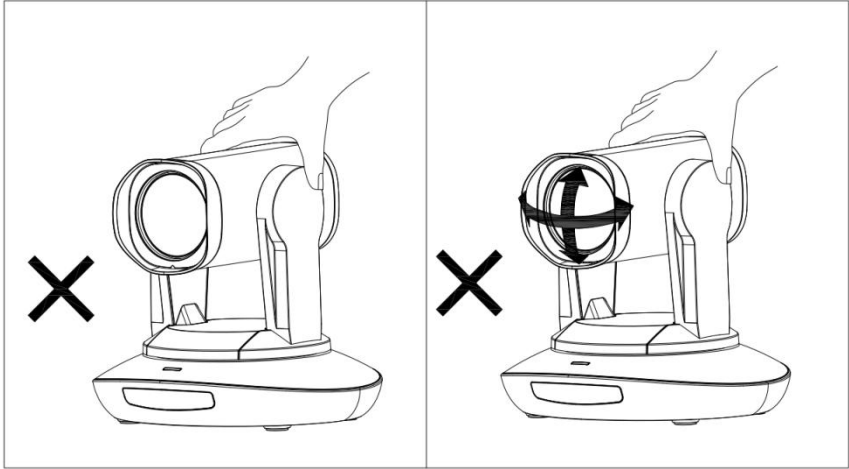

▲ Never grasp the head of the camera, and never move the camera by hand when it is working, otherwise, mechanism maybe destroyed.

Declaration:

■ Instructional Manual is for reference only. Please refer to the actual product.

■ Please contact Customer Service staff for the latest programs and supplementary documentations.

■ In case of any doubt or dispute in the instruction manual, the final interpretation of the company shall prevail.

===== USE CHECK =====

PACKING LIST

Check all below items when open the package

- Camera 1PCS
- Power Adapter..... 1PCS
- Power Cable..... 1PCS
- Remote Controller..... 1PCS
- USB Type-C Cable..... 1PCS
- RS232 Cable..... 1PCS
- User Manual..... 1PCS
- QC PASS..... 1PCS
- Shock-absorbing Pad..... 1PCS

QUICK START

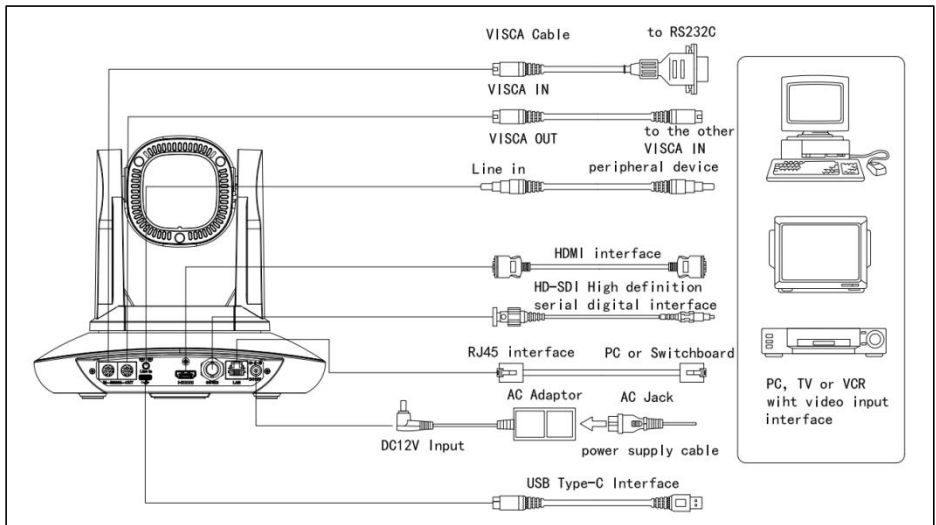

===== USE CHECK =====

Dial Switch Setting (at the bottom of the camera)

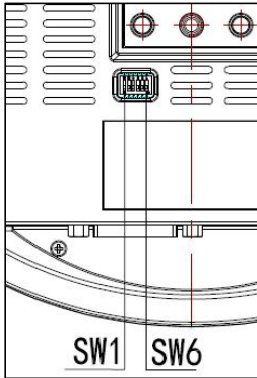

Dial Switch (ARM)			
	SW-1	SW-2	Instruction
1	OFF	OFF	Upgrading mode
2	ON	OFF	Debugging mode
3	OFF	ON	Undefined
4	ON	ON	Working mode

Dial Switch			
	SW-3	SW-4	Instruction
1	OFF	OFF	Reserved
2	ON	OFF	Reserved
3	OFF	ON	Reserved
4	ON	ON	Reserved

Dial Switch			
	SW-5	SW-6	Instruction
1	OFF	OFF	Undefined
2	ON	OFF	Working mode
3	OFF	ON	Undefined
4	ON	ON	Undefined

=== PRODUCT HIGHLIGHTS ===

- ★ Adopting the most advanced image processing DSP, 1/1.8 inch 12MP sensor.
- ★ 4K wide angle optical lens: 30x optical zoom, with 60 degree field of view.
- ★ IP(NDI®|HX) FHD 1080P60 video output, while supporting H.264, H.265 encoding.
- ★ Support POE+: one single ethernet cable to get video, control, and power supply.
- ★ Fast video format switch.
- ★ Special Focusing Algorithm: fast and precise focusing performance when zooming or moving.
- ★ Unique camera design with patent.
- ★ Smooth PTZ mechanical design, accurate pan tilt motor control.
- ★ Support field upgrade, one-click software upgrade through WebUI.
- ★ RJ45(NDI®|HX), HDMI, SDI, USB Type-C outputs, fit for different scenarios.
- ★ Support Line in Audio input.
- ★ Support HDMI, SDI high-quality audio output.
- ★ Standard VISCA, PELCO-D, PELCO-D control protocol, quickly set up through OSD menu.
- ★ Support Auto-Tracking and lock the first person captured by the camera.
- ★ Supplied with multi-functional IR remote controller, can set IP address via OSD menu.
- ★ Standard Sony VISCA over IP protocol, support network video and control transmission simultaneously.
- ★ Support SRT protocol for secure transmission of high-quality, low-latency video over WANs.
- ★ Support RTMP protocol directly streaming to Youtube Live, Facebook Live and other platform.
- ★ Support Auto tracking.
- ★ Multi language menu: support Chinese, English and Russian.



CAMERA SPEC



Vision+ N3 30X	
Sensor	1/1.8inch high quality、1200 MP CMOS Sensor
Video Format	HDMI 1920*1080P60/59.94/50/30/29.97/25/24/23.98 1920*1080I60/59.94/50 1280*720P60/59.94/50/30/29.97/25
	SDI 1920*1080P60/59.94/50/30/29.97/25/24/23.98 1920*1080I60/59.94/50 1280*720P60/59.94/50/30/29.97/25
	USB MJPEG, H.264: 1920*1080P30; 1280*720P30; 1024*576P30; 800*448P30 NV12: 1920*1080P10; 1280*720P25; 1024*576P30; 800*448P30
	IP(NDI® HX) 1920*1080P15~60; 1280*720P15~60; 1024*576P15~60; 640*360P15~30
Video Interface	HDMI, SDI, RJ45(NDI® HX), USB Type-C
Audio Interface	3.5mm Line in
Zoom	30X Optical + 4X Digital
Focal Length	6.91mm~214.64mm
Aperture	F1.35~4.6
View Angel	60°(Far)~2°(Near)
Rotation Angle	Pan: ±170°; Tilt: -30°~+90°;
Rotation Speed	Pan: 0.1°~80°/s; Tilt: 0.1°~60°/s
Preset	Remote controller: 10; RS232: 128; Accuracy: 0.1°
Control Port	RS232 IN, RJ45(NDI® HX)
Network Speed	1000M
Video encode	H.264 / H.265
Bit Rate Control	Variable Bit Rate, Constant Bit Rate
Video Bit Rate	1024~61440kbps
Protocol	HTTP, RTSP, RTMP, Onvif, Visca TCP, Visca UDP, Visca over IP, NDI® HX, Visca Serial, Pelco-P, Pelco-D



CAMERA SPEC



POE+	Supported
Daisy Chain	Support RS232 serial daisy chain
Minimum Lux	0.5lux
White Balance	Auto / Manual / ATW / Push / Indoor / Outdoor / Color Temperature
Exposure	Auto / Manual / Shutter / Iris / Bright
Focus	Auto / Manual
Iris	Auto / Manual
Shutter	Auto / Manual
Auto Track	Supported
Gamma select	Supported
BLC	Supported
2D Noise Reduction	Supported
3D Noise Reduction	Supported
Anti-flicker	OFF, 50Hz, 60Hz
Pan Tilt Flip	Supported
Mirroring	Supported
Input Voltage	DC12V/POE+(IEEE802.3at)
Dimension	220mm×190mm×193.5mm
Net Weight	1.9kg(4.2LBS)
Working Temperature	-10°C~50°C
Working Humidity	≤80%

== INTERFACE DESCRIPTION ==

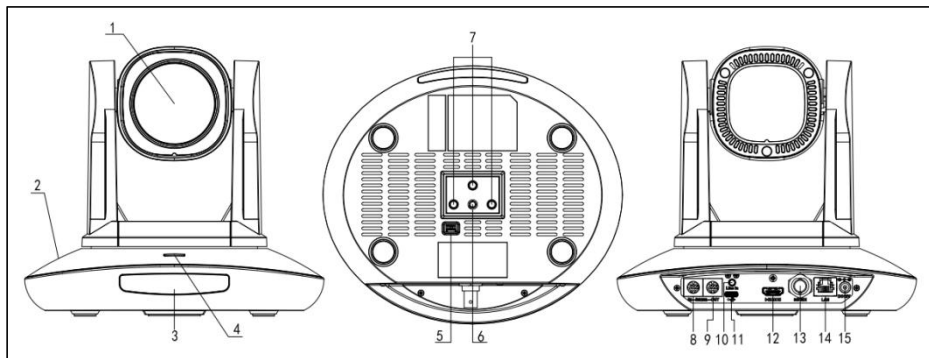

1.Camera Lens

2.Camera Base

3.IR Receiver Panel

4.Power Indicator Light

5.Dial Switch

6.Tripod Screw Hole

7.Installation Hole

8.RS232 ((IN) port

9.RS232 (OUT) port

10.Line in port

11.USB Type-C port

12.HDMI port

13.3G-SDI port

14.RJ45(NDI®)HX port

15.DC 12V plug

==== CAMERA DIMENSION ====

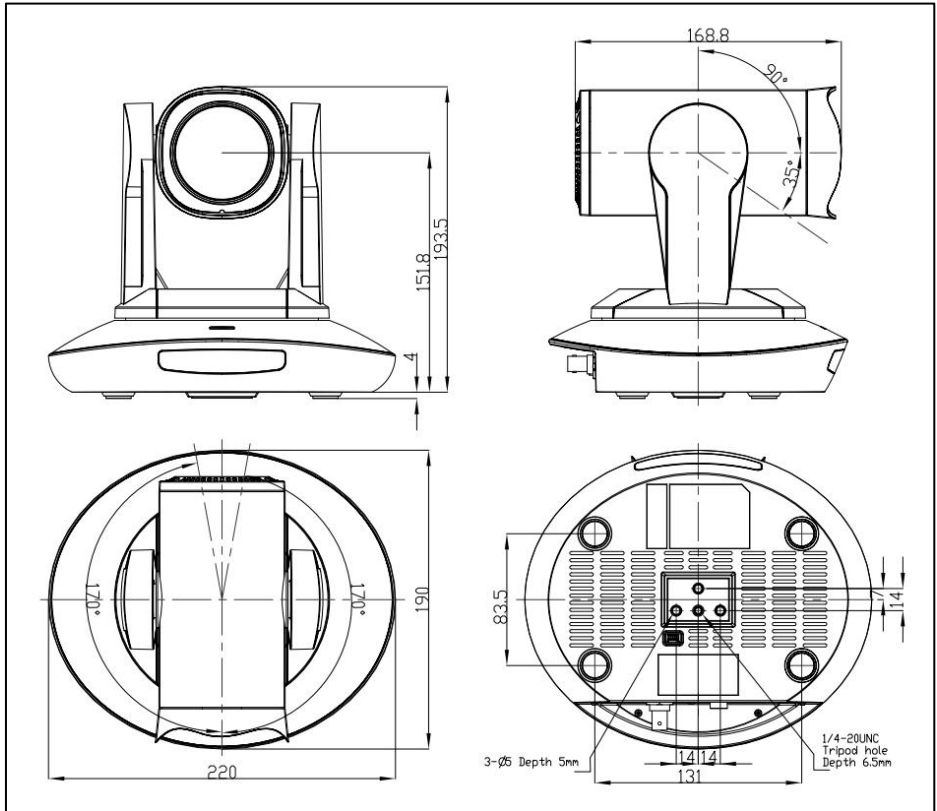



INSTALLATION



Wall-Mount Installation:

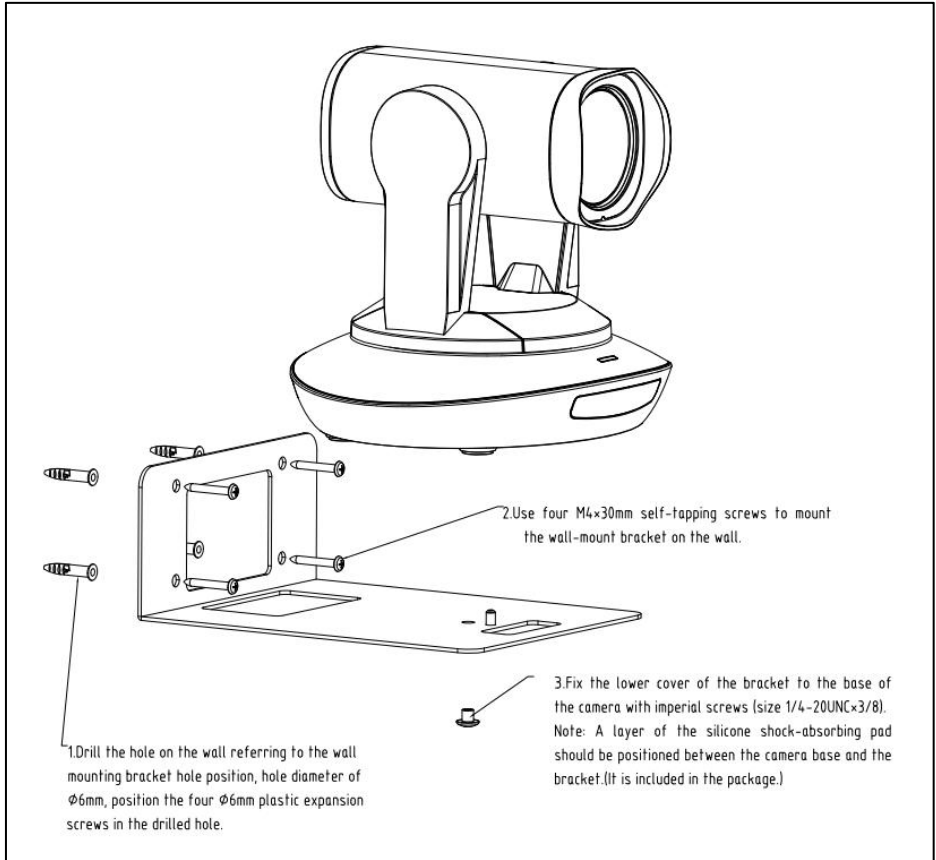

1. Drill the hole on the wall referring to the wall mounting bracket hole position, hole diameter of $\phi 6\text{mm}$, position the four $\phi 6\text{mm}$ plastic expansion screws in the drilled hole.

2. Use four M4 \times 30 self-tapping screws to mount the wall-mount bracket on the wall.

3. Fix the lower cover of the bracket to the base of the camera with imperial screws (SIZE 1/4-20UNC \times 3/8)

Note: A layer of silicone shock-absorbing pad should be positioned between the camera base and the bracket. (It is included in the package)



INSTALLATION



Ceiling-Mount Installation :

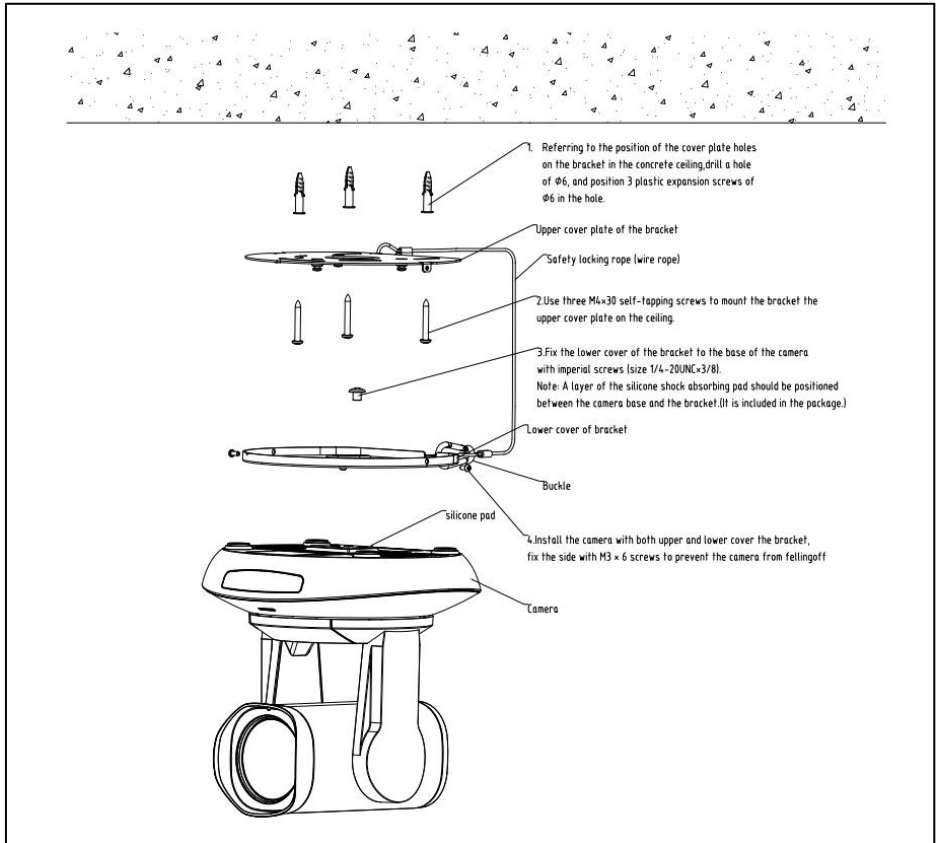

1. Referring to the position of the cover plate holes on the bracket in the concrete ceiling, drill a hole of $\phi 6$, and position 3 plastic expansion screws of $\phi 6$ in the hole.

2. Use three M4*30 self-tapping screws to mount the bracket the upper cover plate on the ceiling.

3. Fix the lower cover of bracket to the base of the camera with imperial screws (Size 1/4-20UNC*3/8)

Note: A layer of silicone shock-absorbing pad should be positioned between the camera base and the bracket. (It is included in the package).

4. Install the camera with both upper and lower cover of the bracket, fix the side with M3*6 screws to prevent the camera from falling off.



VISCA IN (RS232 PORT)



POWER

Short press POWER key to enter standby mode from normal working mode. Press it again, the camera will do self-checking, then go back to HOME position. It will go to preset position if power on mode has been set before.

FREEZE

Short press FREEZE key to freeze/unfreeze the image.

IRT (IR Transfer/IR Pass)

Open/Close the IR pass function. Once press the IRT key, the camera will receive and pass the IR remote control signal to the codec/terminal.(via VISCA IN port)



Set 1 ~ Set 4 ADDRESS SETTING

Long press for 3 seconds until the key light ON, to set camera address.

CAM1 ~ CAM4 (CAMERA SELETING)

Short press to select the relative camera.



NUMBER KEY (1-9)

Set Preset: Long press the number key (3 seconds) to set preset.

Run Preset: Short press the number key to run preset.

CLR PRE (CLEAR PRESET)

CLR PRE+number key: to clear the relative preset.

Long press to clear all presets.



VISCA IN (RS232 PORT)



FOCUS KEY: +/-

Manual focus, only valid under manual focus mode.

ZOOM KEY: +/-

Set the Zoom rate.

NAVIGATE KEY: UP/DOWN/LEFT/RIGHT

Under working mode, use navigate key to set the pan tilt, and select menu when enter OSD.

OK/ HOME KEY:

Under working mode, short press OK to make the camera go back to HOME position; and confirm the selection when enter OSD.



AF/MF: AUTO FOCUS/ MANUAL FOCUS

RESET: Press 3 seconds to reset camera.

MENU: Enter OSD menu under working mode. Use as Go-Back function after entering the menu.



F1: F1+OK: Aging mode (Factory debug use only).

F2: LEARN+F2+1: Calibration mode (Factory debug use only).

F3: Short press: One-touch white balance. (You need to set the white balance mode in the menu to PUSH mode.)

F4: Reserved.



LIMIT L/ LIMIT R/ LIMIT CLR:

LEARN+LIMIT L: Set the pan tilt left limit position.

LEARN+LIMIT R: Set the pan tilt right limit position.

LEARN+LIMIT CLR: Clear the limit position.

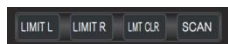

AT CTL: To turn off/on the auto tracking.

AT MODE: Select auto tracking mode. (left/ middle/ right)



BRIGHT-/ BRIGHT+: Set image brightness, only valid under bright priority exposure mode.

VIDEO FORMAT KEYS:

Long press 3 seconds to select different video format output.

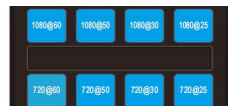



VISCA IN (RS232 PORT)

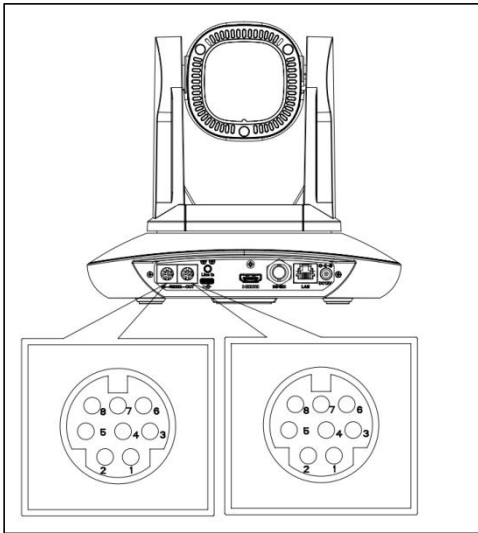

NO.	V_IN	V_OUT
1	DTR	DTR
2	DSR	DSR
3	TXD	TXD
4	GND	GND
5	RXD	RXD
6	A	
7	IR	
8	B	

V_IN	RS485
1	
2	
3	
4	
5	
6	A(+)
7	IR
8	B(-)

VISCA IN 与 Mini DIN

Camera VISCA IN		Mini DIN	
1	DTR	1	DSR
2	DSR	2	DTR
3	TXD	5	RXD
4	GND	4	GND
5	RXD	3	TXD
6	A(+)	6	NC
7	IR OUT	7	NC
8	B(-)	8	NC

VISCA IN 与 DB9 Connection

Camera VISCA IN		Windows DB-9	
1	DTR	6	DSR
2	DSR	4	DTR
3	TXD	2	RXD
4	GND	5	GND
5	RXD	3	TXD
6	A(+)		
7	IR OUT		
8	B(-)		



VISCA IN (RS232 PORT)



VISCA Network Construction:

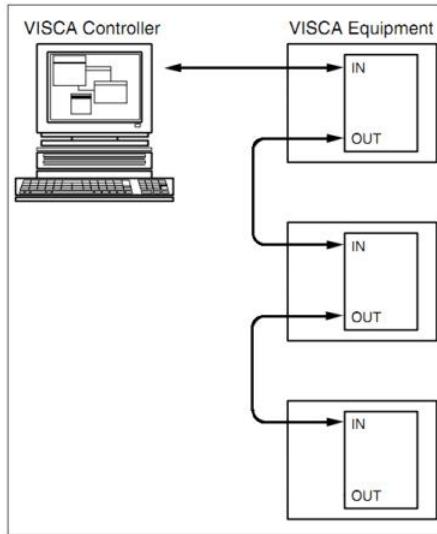

SERIAL PORT CONFIGURATION:

Parameter	Value
Baud rate	2400/4800/9600/115200
Start bit	1bit
Date bit	8bits
Stop bit	1bit
Check bit	None



VISCA PROTOCOL



Part1 Camera Return Command

Ack/Completion Message		
	command	Note
ACK	z0 41 FF	Returned when the command is accepted.
Completion	z0 51 FF	Returned when the command has been executed.

Error Messages		
	command	Note
Syntax Error	z0 60 02 FF	Returned when the command format is different or when a command with illegal command parameters is accepted.
Command Not Executable	z0 61 41 FF	Returned when a command cannot be executed due to current conditions. For example, when commands controlling the focus manually are received during auto focus.

Part2 Camera Control Command

Command type	function	command	
Address Set	Broadcast	88 30 01 FF	Address setting
IF_Clear	Broadcast	88 01 00 01 FF	I/F Clear
Command Cancel		8x 21 FF	
CAM_Power	On	8x 01 04 00 02 FF	Power ON/OFF
	Off	8x 01 04 00 03 FF	Address setting
CAM_Zoom	Stop	8x 01 04 07 00 FF	
	Tele(Standard)	8x 01 04 07 02 FF	
	Wide(Standard)	8x 01 04 07 03 FF	
	Tele(Variable)	8x 01 04 07 2p FF	p = 0(low)~7(high)
	Wide(Variable)	8x 01 04 07 3p FF	
	Direct	8x 01 04 47 0p 0q 0r 0s FF	pqrs: Zoom Position (0(wide) ~0x4000(tele))
Direct with speed	8x 0A 04 47 0t 0p 0q 0r 0s FF	t: spd 0~7 pqrs: Zoom Position (0(wide) ~0x4000(tele))	
CAM_DZoom	ON	8x 01 04 06 02 FF	
	OFF	8x 01 04 06 03 FF	
	Combine Mode	8x 01 04 36 00 FF	Combine with optical
	Separate Mode	8x 01 04 36 01 FF	Separate with optical
	Stop	8x 01 04 06 00 FF	Enable In separate mode
	Tele (Variable)	8x 01 04 06 2p FF	Enable In separate mode
Wide (Variable)	8x 01 04 06 3p FF	Enable In separate mode	



VISCA PROTOCOL



Command type	function	command	
	Direct	8x 01 04 46 0p 0q 0r 0s FF	Enable In separate mode
CAM_Focus	Stop	8x 01 04 08 00 FF	
	Far(Standard)	8x 01 04 08 02 FF	
	Near(Standard)	8x 01 04 08 03 FF	
	Far (Variable)	8x 01 04 08 2p FF	p=0 (Low) to 7 (High)
	Near (Variable)	8x 01 04 08 3p FF	p=0 (Low) to 7 (High)
	Direct	8x 01 04 48 0p 0q 0r 0s FF	pqrs: Focus Position
	Auto Focus	8x 01 04 38 02 FF	
	Manual Focus	8x 01 04 38 03 FF	
	One Push AF	8x 01 04 18 01 FF	
CAM_Zoom Focus	Direct	8x 01 04 47 0p 0q 0r 0s 0t 0u 0v 0w FF	pqrs: Zoom Position (0(wide)~ 0x4000(tele)) tuvw: Focus Position
CAM_WB	Auto	8x 01 04 35 00 FF	
	Indoor	8x 01 04 35 01 FF	
	Outdoor	8x 01 04 35 02 FF	
	One Push	8x 01 04 35 03 FF	
	ATW	8x 01 04 35 04 FF	
	Manual	8x 01 04 35 05 FF	
	One Push Trigger	8x 01 04 10 05 FF	
CAM_R Gain	Reset	8x 01 04 03 00 FF	Manual Control of R Gain
	Up	8x 01 04 03 02 FF	
	Down	8x 01 04 03 03 FF	
	Direct	8x 01 04 43 00 00 0p 0q FF	pq: R Gain (0~0xFF)
CAM_B Gain	Reset	8x 01 04 04 00 FF	Manual Control of B Gain
	Up	8x 01 04 04 02 FF	
	Down	8x 01 04 04 03 FF	
	Direct	8x 01 04 44 00 00 0p 0q FF	pq: B Gain (0~0xFF)
CAM_AE	Full Auto	8x01 04 39 00 FF	Automatic Exposure mode
	Manual	8x 01 04 39 03 FF	Manual Control mode
	Shutter Priority	8x 01 04 39 0A FF	Shutter Priority Automatic Exposure mode
	Iris Priority	8x 01 04 39 0B FF	Iris Priority Automatic Exposure mode
	Bright	8x 01 04 39 0D FF	Bright Mode (Manual control)



VISCA PROTOCOL



Command type	function	command	
CAM_Shutter	Reset	8x 01 04 0A 00 FF	Shutter Setting
	Up	8x 01 04 0A 02 FF	
	Down	8x 01 04 0A 03 FF	
	Direct	8x 01 04 4A 00 00 0p 0q FF	pq: Shutter Position (0~0x15)
CAM_Iris	Reset	8x 01 04 0B 00 FF	Iris Setting(0~0xD)
	Up	8x 01 04 0B 02 FF	
	Down	8x 01 04 0B 03 FF	
	Direct	8x 01 04 4B 00 00 0p 0q FF	pq: Iris Position (0~0x11)
CAM_Gain	Reset	8x 01 04 0C 00 FF	Gain Setting (0~0x0F)
	Up	8x 01 04 0C 02 FF	
	Down	8x 01 04 0C 03 FF	
	Direct	8x 01 04 0C 00 00 0p 0q FF	pq: Gain Positon (0~0x0E)
	GainLimit	8x 01 04 2C 0p FF	p:GainLimt 0x04~0x0F
CAM_AEBright	Reset	8x 01 04 0D 00 FF	Bright Setting
	Up	8x 01 04 0D 02 FF	
	Down	8x 01 04 0D 03 FF	
	Direct	8x 01 04 4D 00 00 0p 0q FF	pq: Bright l Positon (0~0x1B)
CAM_ImageBright	Direct	8x 01 04 A4 00 00 0p 0q FF	pq: Image Bright Positon (0~0x0F) AE_AUTO/AE_SHUTTE R/AE_IRIS
CAM_WDR	On	8x 01 04 3D 02 FF	Exposure Compensation ON/OFF
	Off	8x 01 04 3D 03 FF	
	Direct	8x 01 04 D3 pq FF	pq: ExpComp Position (0~0x6)
CAM_Back Light(BLC)	On	8x 01 04 33 02 FF	BackLight On
	Off	8x 01 04 33 03 FF	BackLight Off
CAM_Sharpness	Reset	8x 01 04 02 00 FF	Aperture Control
	Up	8x 01 04 02 02 FF	
	Down	8x 01 04 02 03 FF	
	Direct	8x 01 04 42 00 00 0p 0q FF	pq: Aperture Gain (0~0x0F)



VISCA PROTOCOL



Command type	function	command	
CAM_Memory(preset)	Reset	8x 01 04 3F 00 pp FF	pp: Preset Number(=0 to 127)
	Set	8x 01 04 3F 01 pp FF	
	Recall	8x 01 04 3F 02 pp FF	
CAM_MemoryH (preset)	Reset	8x 01 04 3F 00 0p 0p FF	pp: Preset Number(=0 to 255) Corresponds to 0 to 9 on the Remote Commander
	Set	8x 01 04 3F 01 0p 0p FF	
	Recall	8x 01 04 3F 02 0p 0p FF	
Freeze	Set	8x 01 04 75 0p FF	p: Freeze switch 3=OFF 2=ON
Preset Freeze Set	Set	8x 01 04 76 0p FF	p: Preset Freeze switch 3= OFF 2=ON
Preset Speed Set	Set	8x 01 7E 01 0B 00 qq FF	qq:Preset speed 2~24 default:15
Preset Speed Adj	adj	8x 01 7E 01 1B 0p FF	p: direction adjustment 3= down 2=up
CAM_LR_Reverse	On	8x 01 04 61 02 FF	Image Flip Horizontal ON/OFF
	Off	8x 01 04 61 03 FF	
CAM_Picture Flip	On	8x 01 04 66 02 FF	Image Flip Vertical ON/OFF
	Off	8x 01 04 66 03 FF	
CAM_RS485Ctl	On	8x 01 06 A5 02 FF	
	Off	8x 01 06 A5 03 FF	
CAM_Saturation	Saturation	8x 01 04 A1 00 00 0p 0q FF	pq:saturation level 0x00~0x0f
CAM_Contrast	Contrast	8x 01 04 A2 00 00 0p 0q FF	pq:Contrast level 0x00~0x0f
CAM_Speed By Zoom	On	8x 01 06 A0 02 FF	
	Off	8x 01 06 A0 03 FF	
CAM_PT Speed	PT Speed	8x 01 04 C1 00 00 0p 0q FF	pq:PT speed 0x05~0x18
CAM_Zoom Speed	Zoom Speed	8x 01 04 D1 00 00 0p 0q FF	pq:Zoom speed 0x01~0x07
CAM_Zoom Display	On	8x 01 06 C2 02 FF	
	Off	8x 01 06 C2 03 FF	
CAM_Freeze	Freeze	8x 01 04 75 0p FF	p: Freeze switch 3=OFF, 2=ON
CAM_Preset Freeze Set	Preset Freeze Set	8x 01 04 76 0p FF	p: Preset Freeze switch 3=OFF, 2=ON
CAM_Preset PT Speed Set	Preset PT Speed Set	8x 01 7E 01 0B 00 qq FF	qq:Preset PT Speed 02~24 default:15



VISCA PROTOCOL



Command type	function	command	
CAM_Preset Zoom Speed Set	Preset Zoom Speed Set	81 01 7E 01 2B 00 qq FF	qq:Preset Zoom Speed 01~07 default:5
CAM_Preset Speed Adj	Preset Speed Adj	8x 01 7E 01 1B 0p FF	p: Adjustment of direction 3=down, 2=up
CAM_IR address	IR address	8x 01 06 D8 0p FF	p:IR address 1~4
CAM_Gamma	Gamma set	8x 01 04 5B 0p FF	P:Gamma NO. (0~4)
CAM_2D Noise Reduction	Direct	8x 01 04 A5 0p FF	(0~0x01)
CAM_3D Noise Reduction	Direct	8x 01 04 53 0p FF	(0~0x05)
CAM_AT_OnOff	Direct	8x 01 04 C8 0p FF	P: 0 = off 1 = on
CAM_AT_TargetChange	Target change	8x 01 04 CA 0p FF	P:0x02 right move P:0x03 left move
CAM_TargetLocation	Target location	8x 01 04 CB 0p FF	P: 0:mid 1:left 2:right
CAM_TargetRatio	Target ratio	8x 01 04 CC 0p 0q FF	Pq:(6~20)Human is 1/pq in the pic
CAM_AT_ChangeTime	Direct	8x 01 04 CD 0p 0q FF	pp: t*10
CAM_AT_BlackBoardMode	Direct	8x 01 04 CE 0p FF	p: 1=Enable 0=Disable
CAM_AT_HilightTarget	Direct	8x 01 04 CF 0p FF	p: 1=Enable 0=Disable
CAM_AT_LeftUp_Limit (preset#251)	Direct	8x 01 04 3F 0p 0F 0B FF	p: 1=Set 2=Call 3=Clear
CAM_AT_RightDown_Limit(preset#253)	Direct	8x 01 04 3F 0p 0F 0D FF	p: 1=Set 2=Call 3=Clear
CAM_AT_InitialPosition (preset#255)	Direct	8x 01 04 3F 0p 0F 0F FF	p: 1=Set 2=Call 3=Clear
CAM_AT_BlackBoard Position(preset#252)	Direct	8x 01 04 3F 0p 0F 0C FF	p: 1=Set 2=Call 3=Clear
CAM_AT_ZoomLock	Direct	8x 01 04 D6 0p FF	p: 1=Enable 0=Disable
CAM_AT_LimitEnable	Direct	8x 01 04 D7 0p FF	p: 1=Enable 0=Disable



VISCA PROTOCOL



Command type	function	command	
CAM_AudioSet	Direct	8x 01 04 D8 0p 0q 0r 0s 0t 0u 0m 0n 0h 0i 0j FF	0p: 0x01-ON 0x00-OFF 0q: 0x01-line in rstu: samplerate mn: volume 0~100 h: encode mode 4: LPCM 5: ACC ij: bitrate*1000
FLICK	50HZ	8x 01 04 23 01 FF	
	60HZ	8x 01 04 23 02 FF	
	OFF	8x 01 04 23 00 FF	
Video System Set(Factory)		8x 01 06 35 00 pp FF	pp: Video format 1080P60 0x00 1080P50 0x01 1080I60 0x02 1080I50 0x03 1080P30 0x04 1080P25 0x05 720P60 0x06 720P50 0x07 720P30 0x08 720P25 0x09 1080P5994 0x0E 1080I5994 0x0F 1080P2997 0x10 720P5994 0x13 720P2997 0x14 1080P24 0x11 1080P2398 0x12
Video System Set(Sony)		8x 01 04 24 72 0p 0q FF	pq: Video format 1080P60 0x2e 1080P50 0x2f 1080I60 0x01 1080I50 0x04 1080P30 0x06 1080P25 0x08 720P60 0x09 720P50 0x0c 720P30 0x0e 720P25 0x11 1080P5994 0x13 1080I5994 0x02 1080P2997 0x07 720P5994 0x0a 720P2997 0x0f 1080P24 0x2a 1080P2398 0x2b



VISCA PROTOCOL



Command type	function	command	
CAM_ID Write		8x 01 04 22 0p 0q 0r 0s FF	pqrs: Camera ID (=0000 to FFFF)
DHCP control	DHCP off	8x 01 04 AE 00 FF	DHCP off
	DHCP on	8x 01 04 AE 01 FF	DHCP on
IP address control	IP set	8x 01 04 AB 0p 0q 0r 0s 0m 0n 0x 0y FF	Set ip to: pq.rs.mn.xy
	Mask set	8x 01 04 AC 0p 0q 0r 0s 0m 0n 0x 0y FF	Set mask to: pq.rs.mn.xy
	Gateway set	8x 01 04 AD 0p 0q 0r 0s 0m 0n 0x 0y FF	Set gateway to : pq.rs.mn.xy
Mainstream	resolution	8x 01 04 C2 00 0p 0q 0r 0s 0m 0n 0x 0y FF	pqrs : Column(x size) mnxy: Line (y size) only support: 1920*1080 1280*720 1024*576
	rate	8x 01 04 C2 01 0p 0q 0r 0s 0m 0n 0x 0y FF	pqrsmnxy: bitrate (1024-61440kbps)
	Encode Mode	8x 01 04 C2 02 0p 0q FF	Mode sel: 0xpq 0x00: h264 0x01: h265
	Frame Rate	8x 01 04 C2 03 0p 0q FF	Frame rate: 0xpq (15~60)
	IDR	8x 01 04 C2 04 0p 0q FF	IDR Setting: 0xpq (1~120)
	Stream Rate Mode	8x 01 04 C2 05 0p 0q FF	Contor mode: 0xpq 0x00: CBR 0x01: VBR
Sub stream	resolution	8x 01 04 C3 00 0p 0q 0r 0s 0m 0n 0x 0y FF	pqrs : Column(x size) mnxy: Line (y size) only support: 640*360
	rate	8x 01 04 C3 01 0p 0q 0r 0s 0m 0n 0x 0y FF	pqrsmnxy: bitrate (1024-20480kbps)
	Encode Mode	8x 01 04 C3 02 0p 0q FF	Mode sel: 0xpq 0x00: h264 0x01: h265
	Frame Rate	8x 01 04 C3 03 0p 0q FF	Frame rate: 0xpq (15~60)
	IDR	8x 01 04 C3 04 0p 0q FF	IDR Setting: 0xpq (1~120)



VISCA PROTOCOL



Command type	function	command	
	Stream Rate Mode	8x 01 04 C3 05 0p 0q FF	Contor mode: 0xpq 0x00: CBR 0x01: VBR
SYS_Menu	Menu On	8x 01 06 06 02 FF	Turn on the menu
	Menu Off	8x 01 06 06 03 FF	Turn off the menu
	Menu Back	8x 01 06 06 10 FF	Menu step back
	Menu OK	8x 01 7E 01 02 00 01 FF	Menu ok
IR_Receive	On	8x 01 06 08 02 FF	IR(remote commander)receive ON/OFF
	Off	8x 01 06 08 03 FF	
	On/Off	8x 01 06 08 10 FF	
Tally control	Tally on/off	8x 01 7E 01 0A 00 0p FF	p: 0: OFF(LED off) 1: (LED green on) 2: (LED red on) 4: (LED blue on)
Pan_tilt Drive	Up	8x 01 06 01 VV WW 03 01 FF	VV: Pan speed 0x01 (low speed) to 0x18 (high speed) WW: Tilt speed 0x01 (low speed) to 0x14 (high speed) YYYY: Pan Position(TBD) ZZZZ: Tilt Position(TBD)
	Down	8x 01 06 01 VV WW 03 02 FF	
	Left	8x 01 06 01 VV WW 01 03 FF	
	Right	8x 01 06 01 VV WW 02 03 FF	
	Up left	8x 01 06 01 VV WW 01 01 FF	
	Up right	8x 01 06 01 VV WW 02 01 FF	
	Down Left	8x 01 06 01 VV WW 01 02 FF	
	Down Right	8x 01 06 01 VV WW 02 02 FF	
	Stop	8x 01 06 01 VV WW 03 03 FF	
	Absolute Position	8x 01 06 02 VV WW 0Y 0Y 0Y 0Y 0Z 0Z 0Z 0Z FF	
	Relative Position	8x 01 06 03 VV WW 0Y 0Y 0Y 0Y 0Z 0Z 0Z 0Z FF	
	Home	8x 01 06 04 FF	
Reset	8x 01 06 05 FF		
Pan-tilt Limit Set	Set	8x 01 06 07 00 0W 0Y 0Y 0Y 0Y 0Z 0Z 0Z 0Z FF	W: 1: Up Right 0: Down Left YYYY: Pan Limit Position(TBD) ZZZZ: Tilt Limit Position(TBD)
	Clear	8x 01 06 07 01 0W 07 0F 0F 0F 07 0F 0F 0F FF	

Part3 Camera Inquiry Command

Command type	command	return	note
CAM_Power Inq	8x 09 04 00 FF	y0 50 02 FF	On
		y0 50 03 FF	Off(Standby)



VISCA PROTOCOL



Command type	command	return	note
CAM_Zoom Pos Inq	8x 09 04 47 FF	y0 50 0p 0q 0r 0s FF	pqrs: Zoom Position
CAM_DZoom On Off Inq	8x 09 04 06 FF	y0 50 0p FF	p: 2: ON 3: OFF
CAM_PT Speed Inq(IR)	8x 09 04 C1 FF	y0 50 pp FF	pp: 0x05~0x18
CAM_Zoom Speed Inq(IR)	8x 09 04 D1 FF	y0 50 0p FF	p:0x00~0x07
CAM_Focus Mode Inq	8x 09 04 38 FF	y0 50 02 FF	Auto Focus
		y0 50 03 FF	Manual Focus
CAM_Focus Pos Inq	8x 09 04 48 FF	y0 50 0p 0q 0r 0s FF	pqrs: Focus Position
CAM_2D_Inq	8x 09 04 A5 FF	y0 50 03 FF	(0~0x01) p: 0: off 1: on
CAM_3D_Inq	8x 09 04 53 FF	y0 50 03 FF	(0~0x05) p:0:off 1: auto 2~5: noise level
CAM_WB Mode Inq	8x 09 04 35 FF	y0 50 00 FF	Auto
		y0 50 01 FF	Indoor mode
		y0 50 02 FF	Outdoor mode
		y0 50 03 FF	OnePush mode
		y0 50 04 FF	ATW
		y0 50 05 FF	Manual
CAM_RGain Inq	8x 09 04 43 FF	y0 50 00 00 0p 0q FF	pq: R Gain
CAM_BGain Inq	8x 09 04 44 FF	y0 50 00 00 0p 0q FF	pq: B Gain
CAM_Saturation Inq	8x 09 04 A1 FF	y0 50 00 00 0p 0q FF	pq: saturation
CAM_Contrast Inq	8x 09 04 A2 FF	y0 50 00 00 0p 0q FF	pq: contrast
CAM_AE Mode Inq	8x 09 04 39 FF	y0 50 00 FF	Full Auto
		y0 50 03 FF	Manual
		y0 50 0A FF	Shutter priority
		y0 50 0B FF	Iris priority
		y0 50 0D FF	Bright
CAM_Flicker Mode Inq	8x 09 04 AA FF	y0 50 0p FF	p: 0: OFF 1: 50HZ 2: 60HZ
CAM_Shutter Pos Inq	8x 09 04 4A FF	y0 50 00 00 0p 0q FF	pq: Shutter Position



VISCA PROTOCOL



Command type	command	return	note
CAM_Iris Pos Inq	8x 09 04 4B FF	y0 50 00 00 0p 0q FF	pq: Iris Position
CAM_Gain Posi Inq	8x 09 04 4C FF	y0 50 00 00 0p 0q FF	pq: Gain Position
CAM_Bright Posi Inq	8x 09 04 4D FF	y0 50 00 00 0p 0q FF	pq: Bright Position
CAM_WDR Mode Inq	8x 09 04 3D FF	y0 50 02 FF	On
		y0 50 03 FF	Off
CAM_Pre PT Speed Inq	8x 09 7E 01 0B FF	y0 50 pp FF	pp: 0x05~0x18
CAM_Pre Zoom Speed Inq	8x 09 7E 01 2B FF	y0 50 pp FF	pp: 0x01~0x07
SYS_Menu Mode Inq	8x 09 06 06 FF	y0 50 02 FF	On
		y0 50 03 FF	Off
CAM_LR_Reverse Inq	8x 09 04 61 FF	y0 50 02 FF	On
		y0 50 03 FF	Off
CAM_Picture Flip Inq	8x 09 04 66 FF	y0 50 02 FF	On
		y0 50 03 FF	Off
CAM_ID Inq	8x 09 04 22 FF	y0 50 0p 0q 0r 0s FF	pqrs: Camera ID
CAM_DHCP Inq	8x 09 04 AE FF	y0 50 pp FF	
CAM_IP Inq	8x 09 04 AB FF	y0 50 0p 0p 0q 0q 0r 0r 0s 0s FF	
CAM_MASK Inq	8x 09 04 AC FF	y0 50 0p 0p 0q 0q 0r 0r 0s 0s FF	
CAM_GATEWAY Inq	8x 09 04 AD FF	y0 50 0p 0p 0q 0q 0r 0r 0s 0s FF	
CAM_Version Inq	8x 09 00 02 FF	y0 50 ab cd mn pq rs tu vw FF	
Tally Inq	8x 09 7E 01 0A FF	y0 50 0p FF	p: tally state
Freeze Inq	8x 09 04 75 FF	y0 50 0p FF	p: Freeze switch 3 = OFF 2 = ON
Preset Freeze Inq	8x 09 04 76 FF	y0 50 0p FF	p: Preset Freeze switch 3 = OFF 2 = ON



VISCA PROTOCOL



Command type	command	return	note
PresetExist Inq	8x 09 04 3F 0p 0p FF	y0 50 0q FF	pp: preset NO. 0~255 q: 0:not saved 1:saved
Preset Speed Set Inq	8x 09 7E 01 0B FF	y0 50 pp FF	pp: Preset Speed 2~24 default:15
CAM_Inq_AT_OnOff	8x 09 04 C8 FF	y0 50 0p FF	P: 0 = off 1 = on
CAM_Inq_AT_TargetChange	8x 09 04 CA FF	y0 50 0p FF	P:0x02 right move P:0x03 left move
CAM_Inq_TargetLocation	8x 09 04 CB FF	y0 50 0p FF	P: 0:mid 1:left 2:right
CAM_Inq_TargetRatio	8x 09 04 CC FF	y0 50 0p 0q FF	Pq:(6~20)Human is 1/pq in the pic
CAM_AT_ChangeTime_Inq	8x 09 04 CD FF	y0 50 0p 0q FF	Pq: t*10
CAM_AT_BlackBoardMode_Inq	8x 09 04 CE FF	y0 50 0p FF	p: 1=Enable 0=Disable
CAM_AT_HilightTarget_Inq	8x 09 04 CF FF	y0 50 0p FF	p: 1=Enable 0=Disable
CAM_AT_ZoomLock_Inq	8x 09 04 D6 FF	y0 50 0p FF	p: 1=Enable 0=Disable
CAM_AT_LimitEnable_Inq	8x 09 04 D7 FF	y0 50 0p FF	p: 1=Enable 0=Disable
CAM_AudioSet	8x 09 04 D8 FF	8x 01 04 D8 0p 0q 0r 0s 0t 0u 0m 0n 0h 0i 0j FF	0p: 0x01-ON 0x00-OFF 0q: 0x01-line in rstu: samplerate mn: volume 0~100 h: encode mode 4: LPCM 5: ACC ij: bitrate*1000
Video System Inq(Factory)	8x 09 06 23 FF	y0 50 pp FF	pp: Video format
Video System Inq(Sony)	8x 09 04 24 72 FF	y0 50 0p 0p FF	pp: Video format
IR_Transfer	8x 09 06 1A FF	y0 50 02 FF	On
		y0 50 03 FF	Off
IR_Receive	8x 09 06 08 FF	y0 50 02 FF	On
		y0 50 03 FF	Off



VISCA PROTOCOL



Command type	command	return	note
Pan-tilt Max Speed Inq	8x 09 06 11 FF	y0 50 ww zz FF	ww: Pan Max Speed zz: Tilt Max Speed
Pan-tilt Pos Inq	8x 09 06 12 FF	y0 50 0w 0w 0w 0w 0z 0z 0z 0z FF	wwww: Pan Position zzzz: Tilt Position
Mainstream Resolution Inq	8x 09 04 C2 00 FF	y0 50 0p 0q 0r 0s 0m 0n 0x 0y FF	pqrs : Column(x size) mnxy: Line (y size) only support: 1920*1080 1280*720 1024*576
Main stream Rate Inq	8x 09 04 C2 01 FF	y0 50 0p 0q 0r 0s 0m 0n 0x 0y FF	pqrsmnxy: bitrate (1024~61440kbps)
Main Encode Mode Inq	8x 09 04 C2 02 FF	y0 50 pp FF	Mode sel:0xpp 0x00: h264 0x01: h265
Main Frame Rate Inq	8x 09 04 C2 03 FF	y0 50 pp FF	Frame rate:0xpp (15~60)
Main IDR Inq	8x 09 04 C2 04 FF	y0 50 pp FF	IDR Setting:0xpp (1~120)
Main Stream Rate Mode Inq	8x 09 04 C2 05 FF	y0 50 pp FF	Contor mode:0xpp 0x00: CBR 0x01: VBR
Sub stream Resolution Inq	8x 09 04 C3 00 FF	y0 50 0p 0q 0r 0s 0m 0n 0x 0y FF	pqrs : Column(x size) mnxy: Line (y size) only support: 640*360
Sub stream Rate Inq	8x 09 04 C3 01 FF	y0 50 0p 0q 0r 0s 0m 0n 0x 0y FF	pqrsmnxy: bitrate (1024~20480kbps)
Sub Encode Mode Inq	8x 09 04 C3 02 FF	y0 50 pp FF	Mode sel:0xpp 0x00: h264 0x01: h265
Sub Frame Rate Inq	8x 09 04 C3 03 FF	y0 50 pp FF	Frame rate:0xpp (15~60)
Sub IDR Inq	8x 09 04 C3 04 FF	y0 50 pp FF	IDR Setting:0xpp (1~120)
Sub Stream Rate Mode Inq	8x 09 04 C3 05 FF	y0 50 pp FF	Contor mode:0xpp 0x00: CBR 0x01: VBR



VISCA PROTOCOL



VISCA PAN TILT ABSOLUTE POSITION VALUE

PAN ANGLE	VISCA value	TILT ANGLE	VISCA value
-170	0xF670	-30	0xFE50
-135	0xF868	0	0x0000
-90	0xFAF0	30	0x01B0
-45	0xFD78	60	0x0360
0	0x0000	90	0x510
45	0x0288		
90	0x0510		
135	0x0798		
170	0x0990		

VISCA PAN TILT SPEED VALUE

Pan(Degree/Second)		Tilt(Degree/Second)	
0	0.3	0	0.3
1	1	1	1
2	1.5	2	1.5
3	2.2	3	2.2
4	2.4	4	3.6
5	2.6	5	4.7
6	2.8	6	6
7	3.0	7	8
8	3.2	8	10
9	3.4	9	12
10	3.8	10	15
11	4.5	11	18
12	6	12	23
13	9	13	30
14	15	14	39
15	19	15	48
16	25	16	59
17	32	17	69
18	38	18	80
19	45		
20	58		
21	75		
22	88		
23	105		
24	120		

■■■■ PELCO-D PROTOCOL ■■■■

Function	Byte1	Byte2	Byte3	Byte4	Byte5	Byte6	Byte7
Up	0xFF	Address	0x00	0x08	Pan Speed	Tilt Speed	SUM
Down	0xFF	Address	0x00	0x10	Pan Speed	Tilt Speed	SUM
Left	0xFF	Address	0x00	0x04	Pan Speed	Tilt Speed	SUM
Right	0xFF	Address	0x00	0x02	Pan Speed	Tilt Speed	SUM
Up left	0xFF	Address	0x00	0x0C	Pan Speed	Tilt Speed	SUM
Up right	0xFF	Address	0x00	0x0A	Pan Speed	Tilt Speed	SUM
Down Left	0xFF	Address	0x00	0x14	Pan Speed	Tilt Speed	SUM
Down Right	0xFF	Address	0x00	0x12	Pan Speed	Tilt Speed	SUM
Zoom In	0xFF	Address	0x00	0x20	0x00	0x00	SUM
Zoom Out	0xFF	Address	0x00	0x40	0x00	0x00	SUM
Focus Far	0xFF	Address	0x00	0x80	0x00	0x00	SUM
Focus Near	0xFF	Address	0x01	0x00	0x00	0x00	SUM
Set Preset	0xFF	Address	0x00	0x03	0x00	Preset ID	SUM
Stop	0xFF	Address	0x00	0x00	Pan Speed	Tilt Speed	SUM
Clear Preset	0Xff	Address	0x00	0x05	0x00	Preset ID	SUM
Call Preset	0Xff	Address	0x00	0x07	0x00	Preset ID	SUM
Query Pan Position	0Xff	Address	0x00	0x51	0x00	0x00	SUM
Query Pan Position Response	0Xff	Address	0x00	0x59	Value High Byte	Value Low Byte	SUM
Query Tilt Position	0Xff	Address	0x00	0x53	0x00	0x00	SUM
Query Tilt Position Response	0Xff	Address	0x00	0x5B	Value High Byte	Value Low Byte	SUM
Query Zoom Position	0Xff	Address	0x00	0x55	0x00	0x00	SUM
Query Zoom Position Response	0Xff	Address	0x00	0x5D	Value High Byte	Value Low Byte	SUM

■■■■ PELCO-P PROTOCOL ■■■■

Function	Byte1	Byte2	Byte3	Byte4	Byte5	Byte6	Byte7	Byte8
Up	0Xa0	Address	0x00	0x08	Pan Speed	Tilt Speed	0Xaf	XOR
Down	0Xa0	Address	0x00	0x10	Pan Speed	Tilt Speed	0Xaf	XOR
Left	0Xa0	Address	0x00	0x04	Pan Speed	Tilt Speed	0Xaf	XOR
Right	0Xa0	Address	0x00	0x02	Pan Speed	Tilt Speed	0Xaf	XOR
Up left	0Xa0	Address	0x00	0x0C	Pan Speed	Tilt Speed	0Xaf	XOR
Up right	0Xa0	Address	0x00	0x0A	Pan Speed	Tilt Speed	0Xaf	XOR
Down Left	0Xa0	Address	0x00	0x14	Pan Speed	Tilt Speed	0Xaf	XOR
Down Right	0Xa0	Address	0x00	0x12	Pan Speed	Tilt Speed	0Xaf	XOR
Zoom In	0Xa0	Address	0x00	0x20	0x00	0x00	0Xaf	XOR
Zoom Out	0Xa0	Address	0x00	0x40	0x00	0x00	0Xaf	XOR
Focus Far	0Xa0	Address	0x00	0x80	0x00	0x00	0Xaf	XOR
Focus Near	0Xa0	Address	0x01	0x00	0x00	0x00	0Xaf	XOR
Stop	0Xa0	Address	0x00	0x00	Pan Speed	Tilt Speed	0Xaf	XOR
Set Preset	0xA0	Address	0x00	0x03	0x00	Preset ID	0xAF	XOR
Clear Preset	0xA0	Address	0x00	0x05	0x00	Preset ID	0xAF	XOR
Call Preset	0xA0	Address	0x00	0x07	0x00	Preset ID	0xAF	XOR
Query Pan Position	0xA0	Address	0x00	0x51	0x00	0x00	0xAF	XOR
Query Pan Position Response	0xA0	Address	0x00	0x59	Value High Byte	Value Low Byte	0xAF	XOR
Query Tilt Position	0xA0	Address	0x00	0x53	0x00	0x00	0xAF	XOR
Query Tilt Position Response	0xA0	Address	0x00	0x5B	Value High Byte	Value Low Byte	0xAF	XOR
Query Zoom Position	0xA0	Address	0x00	0x55	0x00	0x00	0xAF	XOR
Query Zoom Position Response	0xA0	Address	0x00	0x5D	Value High Byte	Value Low Byte	0xAF	XOR



OSD MENU



1. Under working mode, press the MENU key on the IR remote controller, to enter the OSD menu as below:

MENU			
SYSTEM	PROTOCOL	< VISCA >	
EXPOSURE	ADDRESS	< 001 >	
IMAGE	BAUDRATE	< 9600 >	
QUALITY	PROTOCOL LOCK	< OFF >	
PTZ SETTINGS	RS485	< ON >	
VIDEO FORMAT	LANGUAGE	< ENGLISH >	
IP SETTINGS	AUTO TRACKING	< OFF >	
RESET	AT LOCATION	< MIDDLE >	
INFORMATIONS	AT RATIO	< 1/16 >	

2. After entering the main menu, use the navigate UP/DOWN key to select the main menu. Once selected, the main menu will change to the blue background, and the right side will show sub-menu options.

3. Press the navigate RIGHT key to enter the sub-menu; use the UP/DOWN key to select the sub-menu; use the LEFT/RIGHT key to select the parameter.

4. Press the MENU key again to return to the previous menu. Press the MENU key continuously to exit the OSD menu.

5. OSD Menu Setting List

SYSTEM	PROTOCOL	Optional: VISCA, PLC.P, PLC.D	Default: VISCA
	ADDRESS	VISCA:: 1~7 PLC-P/D: 0~255	Default: 1
	BAUDRATE	Optional: 2400, 4800, 9600, 115200	Default: 9600
	PROTOCOL LOCK	Optional: OFF, ON	Default: OFF
	RS485	Optional: OFF, ON	Default: ON
	LANGUAGE	Optional: ZH-CH, ENGLISH, ZH-TW, RUSSIAN	Default: ENGLISH
	AT TRACKING	Optional: OFF, ON	Default: OFF
	AT LOCATION	Optional: MIDDLE、LEFT、RIGHT	Default: MIDDLE
	AT RATIO	Optional: 1/6~1/20	Default: 1/16



OSD MENU



EXPOSURE	EXPOSURE MODE	AUTO、MANUAL、SHUTTER、IRIS、BRIGHT	Default: AUTO
	SHUTTER	Shutter speed: 1/30~1/10000, only valid under MANUAL and SHUTTER mode	Default: AUTO
	IRIS	Iris setting: CLOSE~F1.8, only valid under MANUAL and IRIS mode	Default: AUTO
	GAIN	Gain setting: 0dB~30dB, only valid under MANUAL mode	Default: AUTO
	EXPOSURE BRIGHT	Bright setting: 0~27, only valid under BRIGHT priority mode.	Default: AUTO
	BRIGHT	0~15	Default: 8
	WIDE DYNAMIC MODE	OFF/ON	Default: OFF
	WIDE DYNAMIC LEVEL	1~6	Default: 1
	BLC	OFF/ON	Default: OFF

IMAGE	WHITE BALANCE MODE	Optional: ATW, MANUAL, AUTO, INDOOR, OUTDOOR, PUSH, C.T.	Default: ATW
	RED GAIN	Red gain level: 0~255, only valid under manual white balance mode	Default: AUTO
	BLUE GAIN	Blue gain level:0~255 , only valid under manual white balance mode	Default: AUTO
	COLOR TEMPERATURE	Set the color temperature value: 2500~10000 only valid under C.T. mode	Default: AUTO
	FLICKER	Anti-Flicker setting:50/60HZ/OFF, to reduce the video flicker	Default: 50HZ
	DIGITAL ZOOM	OFF/ON	Default: OFF
	FOCUS MODE	AUTO, MANUAL	Default: AUTO
	3G SDI	Optional: LEVELA, LEVELB	Default: LEVELA
	FOCUS NEAR LIMIT	Optional: 1.5M、 2M、 3M、 6M、 10M	Default: 1.5M

QUALITY	2D NOISE REDUCTION	2D noise reduction: the bigger value is, the less noise on image is, the lower resolution is	Default: OFF
	3D NOISE REDUCTION	3D noise reduction: OFF/AUTO/0~4, the bigger value is, the less motion noise on image is. High value will cause image smear.	Default: AUTO
	SHARPNESS	Sharpness setting: 0~15, the higher value is, edge of the image will be sharpened	Default: 6



OSD MENU



	CONTRAST	Set contrast level: 0~15	Default: 8
	SATURATION	Set saturation level: 0~15	Default: 8
	GAMMA	Select gamma level: 0~15	Default: 8
	IMAGE STYLE	USER, NORMAL, COLORFULL	Default: USER
	FOCUS SENSITIVITY	HIGH, NORMAL, LOW	Default: NORMAL

PTZ SETTINGS	SPEED BY ZOOM	Optional: OFF, ON	Default: ON
	FLIP	Flip horizontal	Default: OFF
	MIRROR	Flip vertical	Default: OFF
	PT SPEED	Set Pan Tilt speed: 5~24	Default: 18
	ZOOM SPEED	Set Zoom speed: 1~7	Default: 5
	PRESET FREEZE	Optional: OFF, ON	Default: OFF
	PRESET PT SPEED	Preset head speed:2~24	Default: 18
	PRESET ZOOM SPEED	Preset zoom speed:1~7	Default: 5
	PRESET SAVE AE&AW	Optional: OFF, ON	Default: OFF

VIDEO FORMAT	SIZE	1080P, 1080I, 720P
	FRAME RARE	60, 59.94, 50, 30, 29.97, 25, 24, 23.98
	VI FRAME RARE	60, 50, 30, 25

IP SETTINGS	DHCP	OFF/ON
	IP	192.168.001.188 (Example)
	MASK	255.255.255.000 (Example)
	GATEWAY	192.168.001.001 (Example)
	MAIN SIZE	Current main stream resolution
	BITRATE	Current main stream bit rate
	SUB SIZE	Current sub stream resolution
	BITRATE	Current sub stream bit rate

RESET	SYSTEM RESET	Reset communication parameter to default
	CAMERA RESET	Reset image parameter to default
	PAN TILI RESET	Reset pan/tilt parameter to default
	ALL RESET	Reset all parameter to default



OSD MENU



INFO RMATIONS	IR ADDRESS	Camera IR control address
	CLIENT	VISCA
	MODEL NO.	Model number
	ARM VERSION	ARM firmware version
	ISP VERSION	Camera ISP firmware version
	RELEASE DATE	Software release date

Set IP Address in Menu

In order to help customers debug, the camera has the support menu to set the IP address. The specific methods are as follows.

1. Press "MENU" to open the menu interface, and select "network parameters" in the menu to call up the IP setting interface.

MENU	
SYSTEM	DHCP : < OFF >
EXPOSURE	IP : 192.168.001.188
IMAGE	MASK : 255.255.255.000
QUALITY	GATEWAY : 192.168.001.001
PTZ SETTINGS	
VIDEO FORMAT	
IP SETTINGS	
RESET	
INFORMATIONS	

2. Press the right navigation button to enter the IP setting interface, and select the parameters needed by using the navigation up and down buttons, and then select the IP address, mask, gateway.

3. Short-press the number button to set the corresponding parameters. After setting the parameter, press the "MENU" button again to complete the current parameter setting.

4. To exit the menu, just press the "MENU" button again.

■■■■■■■■ UVC CONTROL ■■■■■■■■

1. Only run the client's software after the camera has completed self-configuration (the IR indicator in blue color and will not flash); otherwise may cause black screen issue.
2. Make sure the camera is recognized by the PC Device Manager.
3. Make sure the interval of video format switching more than 1 seconds, otherwise black video maybe caused.
4. Make sure the interval of control command sending from the server (via USB) to the camera no less than 250ms.
5. Support standard UVC interface.

UVC properties	VISCA
PU_BACKLIGHT_COMPENSATION_CONTROL	8x 01 04 33 02 FF
CY_FX_UVC_PU_BRIGHTNESS_CONTROL	8x 01 04 A4 00 00 0p 0q FF
CY_FX_UVC_PU_CONTRAST_CONTROL	8x 01 04 A2 00 00 0p 0q FF
CY_FX_UVC_PU_SATURATION_CONTROL	8x 01 04 A1 00 00 0p 0q FF
CY_FX_UVC_PU_SHARPNESS_CONTROL	8x 01 04 42 00 00 0p 0q FF
CY_FX_UVC_PU_GAMMA_CONTROL	8x 01 04 5B 0p FF
CY_FX_UVC_PU_WHITE_BALANCE_TEMPERATURE_CONTROL	8x 01 04 35 0p FF
CY_FX_UVC_PU_BACKLIGHT_COMPENSATION_CONTROL	8x 01 04 33 0p FF
CY_FX_UVC_PU_GAIN_CONTROL	8x 01 04 49 00 00 0p 0q FF
CY_FX_UVC_PU_POWER_LINE_FREQUENCY_CONTROL	8x 01 04 AA 0p FF
PU_GAIN_CONTROL	8x 01 04 49 00 00 00 0p FF
CT_ZOOM_ABSOLUTE_CONTROL	8x 01 04 47 0p 0q 0r 0s FF
CT_PANTILT_ABSOLUTE_CONTROL	8x 01 06 02 VV WW 0Y 0Y 0Y 0Y 0Z 0Z 0Z 0Z FF
CT_PANTILT_RELATIVE_CONTROL	8x 01 06 01 pp qq rr ss FF
CT_ZOOM_RELATIVE_CONTROL	8x 01 04 07 pp FF



WEB SETTING



It is not necessary to install additional video player plug-in to preview the local screen on the web interface.

The web interface supports Google Chrome, Firefox, IE, Safari, Opera, 360, QQ and other browsers, adaptability is very good.

1. Login

Run browser, input IP address(defaulted IP address is 192.168.1.188), to enter login interface, can select Language (Chinese, English, Korean, Portuguese or Spanish), input admin and password to login as following: **(Default Username: admin Default password: admin)**



2. PTZ Control

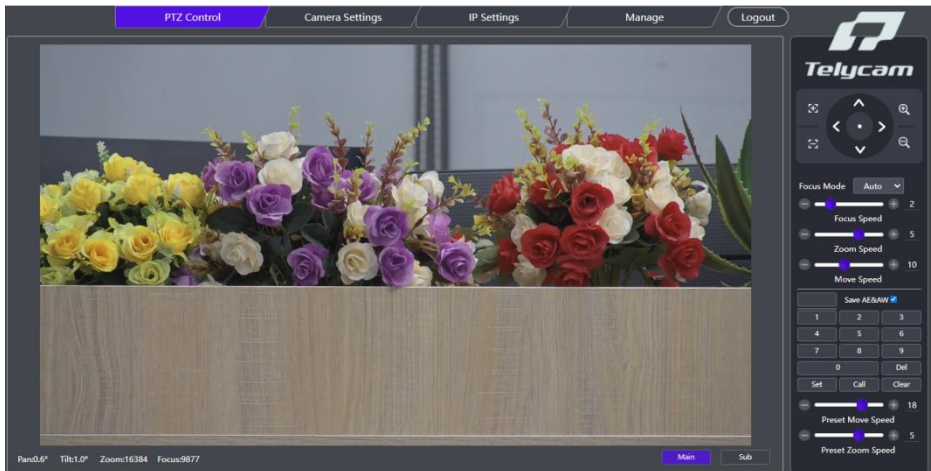

After successful login, the interface is shown in the above figure. The



WEB SETTING



preview interface is displayed on the left, and the functions of camera pan tilt rotation, zoom, focus, and preset position settings can be controlled on the right. Additionally, parameters such as pan tilt and zoom speed can be set through the scroll bar.

3. Camera Settings

Click on the "Camera Settings" option to enter the camera settings interface, as shown in the following figure:

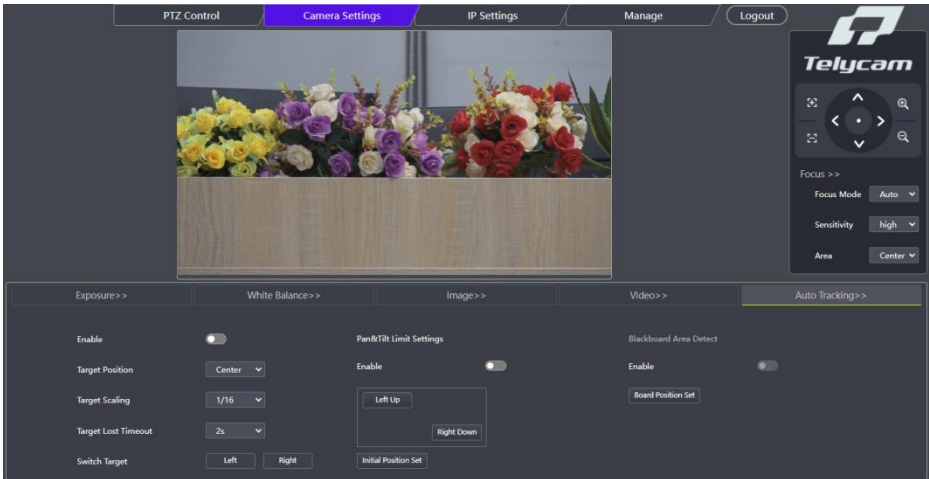

The "Exposure" option allows you to set exposure mode, anti-flicker, shutter, gain, iris, brightness, and other settings, as shown in the following figure:

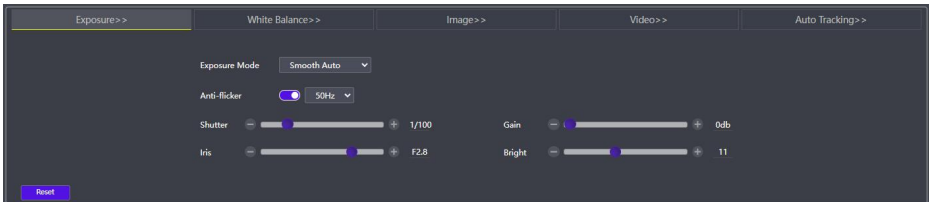

The "White Balance" option includes settings such as white balance mode, red gain, blue gain, and color temperature, as shown in the following figure:



WEB SETTING

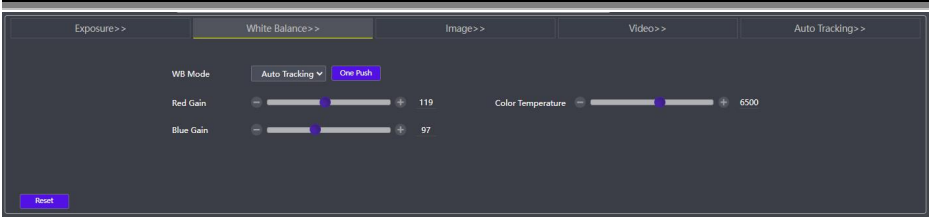

The "Image" option includes settings such as saturation, contrast, sharpness, brightness, backlight compensation, wide dynamic, 2D noise reduction, 3D noise reduction, gamma, etc., as shown in the following figure:



The "Video" option includes settings such as output mode, VI frame rate, digital output, mirror, flip, and digital zoom, as shown in the following figure:

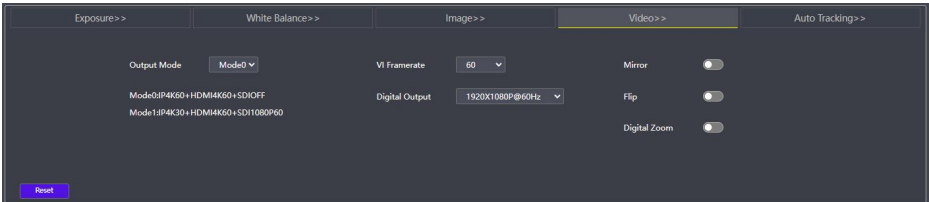

The "Auto Tracking" option includes settings such as tracking switch, target position, target scaling, target loss timeout, target switching, pan tilt limit setting, whiteboard setting, etc., as shown in the following figure:

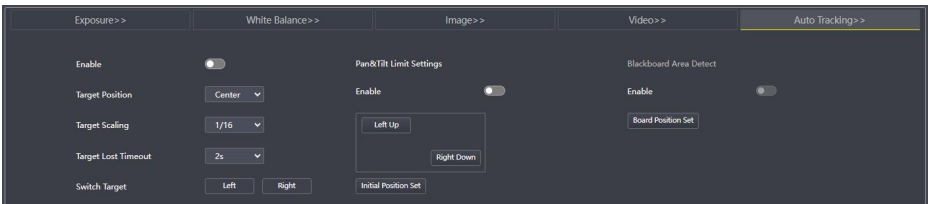



WEB SETTING



4. IP Settings

Click on the "IP Settings" option to enter the camera IP settings interface, as shown in the following figure:

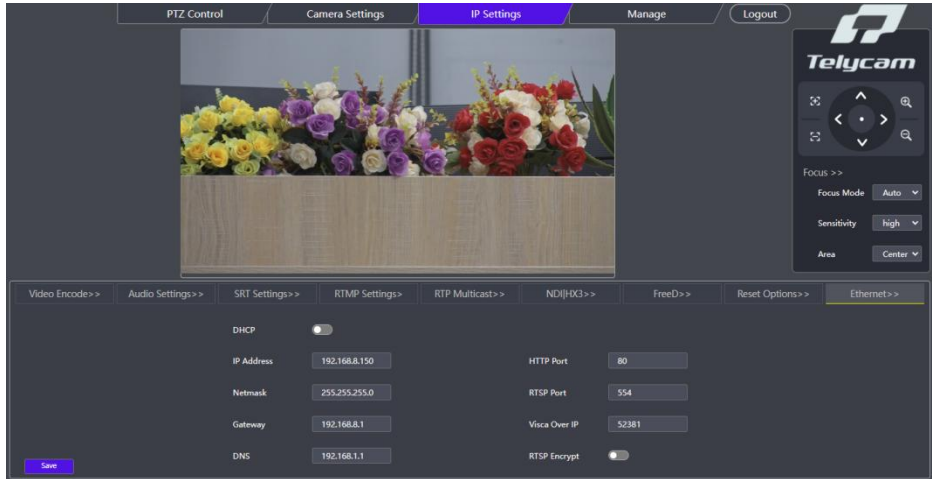

The "Video Encoding" option includes settings such as main and sub stream enable, encoding mode, profile, resolution, bit rate, frame rate, bit rate control, I frame interval, RTSP address, etc., as shown in the following figure:

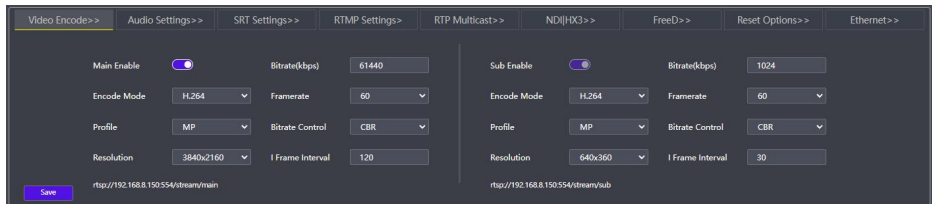

The "Audio Settings" option includes settings such as audio switch, encode mode, sample rate, bit rate, volume, etc., as shown in the following figure:

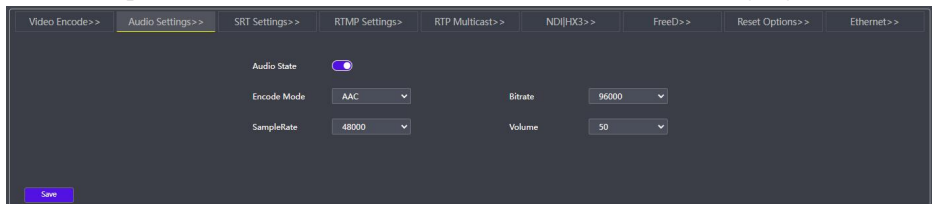

The "SRT Settings" option includes settings such as mode selection, enable



WEB SETTING



switch, port, latency, encryption switch, etc., as shown in the following figure:

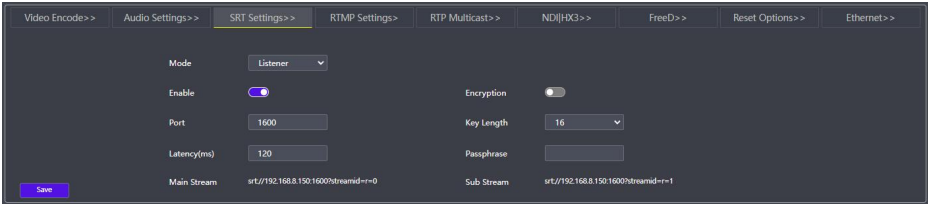

The "RTMP Settings" option includes enable switches and RTMP address settings, as shown in the following figure:

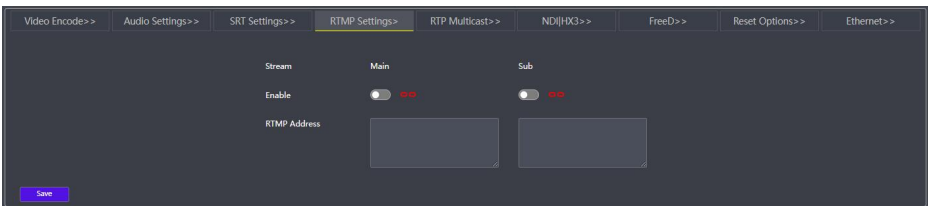

The "RTP multicast" option includes settings such as enable switch, multicast IP, multicast port, RTSP address, RTP address, etc., as shown in the following figure:

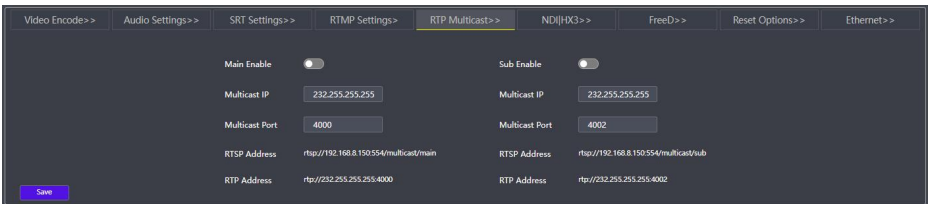

The "NDI | HX3" option includes settings such as NDI enable switch, HX3 switch, device name, channel name, multicast, etc., as shown in the following figure:

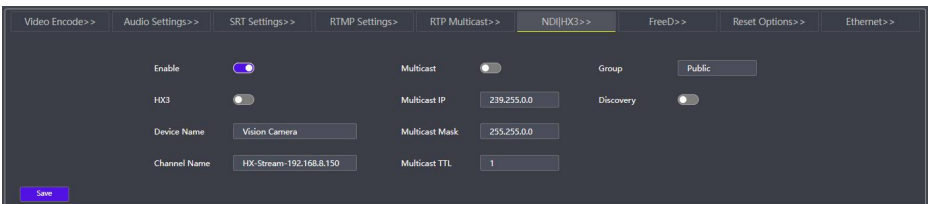

The "FreeD" option includes settings such as enable switch, camera ID,



WEB SETTING



mode, IP address, port, interval, etc., as shown in the following figure:

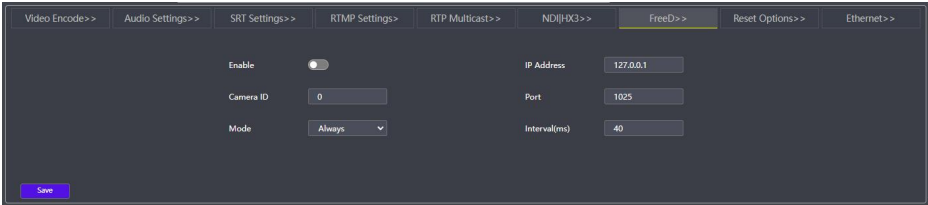

The "Reset Options" option includes settings such as reset, reset/reboot, reboot, and parameter batch configuration, as shown in the following figure:

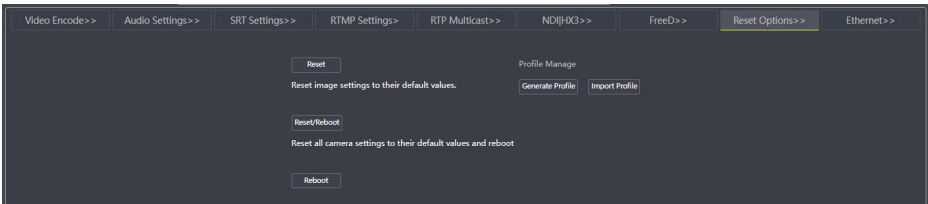

The "Ethernet" option includes parameters such as automatic allocation switch, IP address, net mask, gateway, HTTP port, RTSP port, Visca over IP port, RTSP encryption, etc., as shown in the following figure:

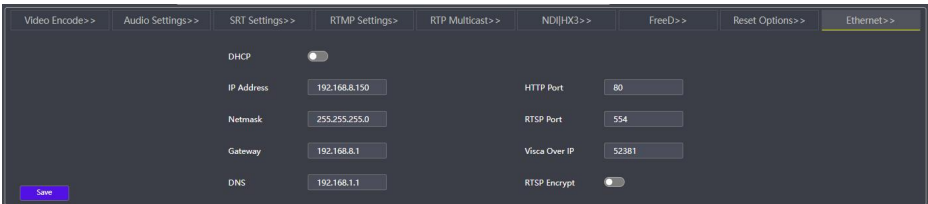

5. Manage

Click on the "Manage" option to enter the camera management interface, as shown in the following figure:



WEB SETTING

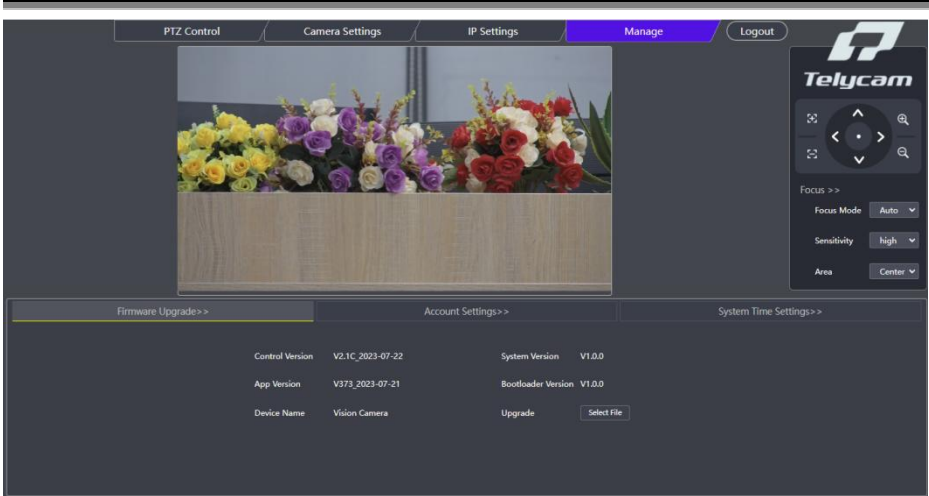

The "Firmware Upgrade" option allows you to view the device name, camera software and hardware version number, and upgrade the camera program through the "Select File" column, as shown in the following figure:

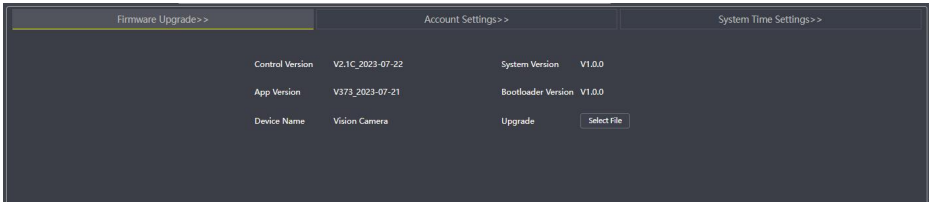

The "Account Settings" option allows you to set the login account and password for the camera:

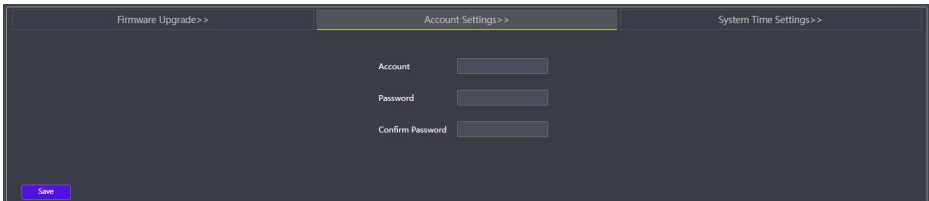

The "Time Settings" option includes settings for NTP activation, time zone, update interval, NTP server address, and port, as shown in the following figure:



WEB SETTING



Firmware Upgrade>>	Account Settings>>	System Time Settings>>
NTP Enable	<input checked="" type="checkbox"/>	
Time Zone	UTC-6:00	NTP Server Address
NTP Update Interval	24h	time.nist.gov
		NTP Port
		80
<input type="button" value="Save"/>		

6. Logout

Click "Logout" to return to the login interface.

== VIEW RTSP VIDEO VIA VLC ==

Default RTSP main streaming address:

rtsp://192.168.1.188/stream/main

Default RTSP sub streaming address:

rtsp://192.168.1.188/stream/sub

Default RTMP main streaming address:

rtmp://192.168.1.188:1935/app/rtmpstream0

Default RTMP sub streaming address:

rtmp://192.168.1.188:1935/app/rtmpstream1

1. Run VLC Media Player.
2. Media->network stream, to enter into “open media” interface.
3. Input RTSP address in URL as following:



4. Click play to view the real time image.

Note: If there is much image lag, select “more option” to enter into following setting, change buffer time smaller (VLC default buffer time is 1000ms).





NDI Tools Guide



1. Image Preview

A. Download the NDI Tools via <https://ndi.tv/tools/> and install it.

B. Find out the NDI 5 Tools/Studio Monitor via Windows toolbars, and then open it, as bellow:



C. Right click on the Studio Monitor screen, select the preview device:

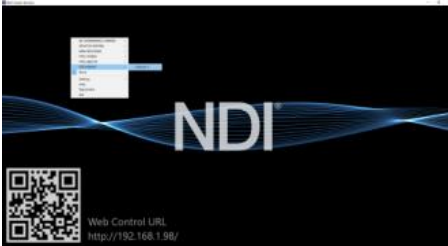

2. Pan Tilt Control



Refer to above picture, once open the video via Studio Monitor, it will show up the control panel on the right side, to control camera pan, tilt, zoom, focus, preset, focus.

3. Run WEB via Studio Monitor

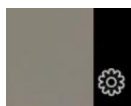



NDI Tools Guide



Refer to above picture, once open the video via Studio Monitor, there will show up a setting icon at the lower right corner, single click this icon to enter WEB UI.

4. How to use NDI tools to Virtual Input CAMERA

A. Find out the NDI Tools/Virtual Input via Windows toolbars, open it, then it will show up the NDI Virtual Input icon at the Windows toolbars, as bellow picture shows:



B. Right click on the NDI Virtual Input icon, to select the virtual device name:

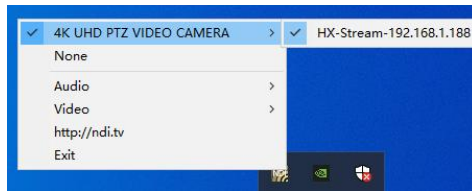

C. Take Zoom for example, select NDI Video as video camera, as bellow picture shows:

This also work for other applications, such as GotoMeeting, Skype for Business, Hangouts.

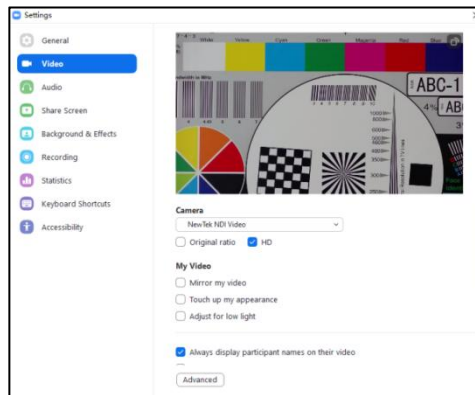

■■■■■■■■■■ VISCA over IP ■■■■■■■■■■

VISCA over IP:

VISCA over IP means VISCA protocol transmit via IP, to reduce RS232/RS485 cable layout (the controller must support IP communication function)

Communication port spec:

- Control port: RJ45 Gigabit LAN
- IP protocol: IPv4
- Transmit protocol: UDP
- IP address: set via web end or OSD menu
- Port address: 52381
- Confirm send/transmission control: depend on applied program
- Applied range: in the same segment, not suitable for bridge network
- Turn on camera: In the menu, set VISCA option to OVER IP or OVER ALL

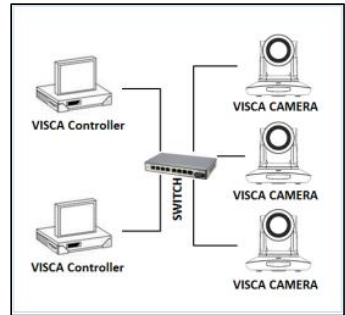

IP Networking method

How to use VISCA over IP

VISCA Command

It means commands from controller to peripheral equipment, when peripheral equipment receives commands, then return ACK. When commands executed, will return complete message.

For different commands, camera will return different message.

VISCA Inquiry

It means inquiry from controller to peripheral equipment when peripheral equipment receives this kind of commands, it will return required message.

VISCA Reply

It means ACK, complete message, reply or error reply, it is sent from peripheral equipment to controller.

Command format: the following is message head and valid message format.

VISCA over IP

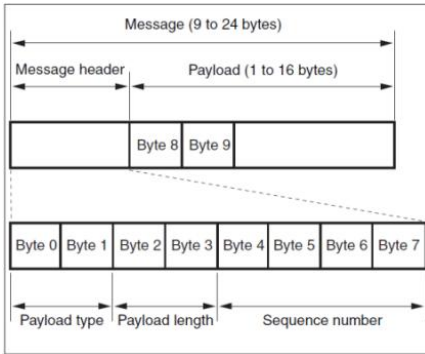

Note: LAN output way is big-endian, LSB is in the front.

Payload type:

Data definition as following:

Name	Value (Byte 0)	Value (Byte1)	Value
VISCA command	0x01	0x00	Stores the VISCA command.
VISCA inquiry	0x01	0x10	Stores the VISCA inquiry.
VISCA reply	0x01	0x11	Stores the reply for the VISCA command and VISCA inquiry, or VISCA device setting command.
VISCA device setting command	0x01	0x20	Stores the VISCA device setting command.
Control command	0x02	0x00	Stores the control command.
Control reply	0x02	0x01	Stores the reply for the control command.

Payload length

Valid data length in Payload (1~16), is command length.

For example, when valid data length is 16 byte

Byte 2 : 0x00

Byte 3 : 0x10

Controller will save sequence number of each command, when one command sent, the sequence number of the command will add 1, when the sequence number becomes the max value, it will change to 0 for next time. The peripheral

■■■■■■■■■■ VISCA over IP ■■■■■■■■■■

equipment will save sequence number of each command, and return the sequence number to the controller.

Payload

According to Payload type, the following data will be saved.

- VISCA command
Save VISCA command packet
- VISCA inquiry
Save VISCA message packet
- VISCA reply
Save VISCA return packet
- VISCA device setting command
Save VISCA equipment setting command packet.
- Control command

The following data is saved in control command payload

Name	Value	Description
RESET	0x01	Resets the sequence number to 0. The value that was set as the sequence number is ignored.
ERROR	0x0Fyy	yy=01:Abnormality in the sequence number.
		yy=02:Abnormality in the message(message type).

- Controlled reply

The following data is saved in return command payload of control command.

Message	Value	Description
ACK	0x01	Reply for RESET.

Delivery confirmation

VISCA over IP uses UDP as transmission communication protocol, UDP communication message transmission is not stable, it is necessary to confirm delivery and resent in application.

Generally, when controller sends a command to peripheral equipment,

■■■■■■■■■■ VISCA over IP ■■■■■■■■■■

controller will wait for the return message then send the next command, we can detect and confirm if the peripheral equipment receive the commands from return message's lag time. If controller shows it is overtime, it is regarded as error transmission.

If controller shows it is overtime, resend the commands to check peripheral's status, resent command sequence number is same as last command, the following chart list the received message and status after resending the commands.

Lost message	Received message for retransmission	Status after retransmission	Correspondence after retransmission
Command	ACK message	Command is performed by retransmission.	Continue processing.
Completion message For the command	ERROR(Abnormality in the sequence number.)	Command has been performed. If only the ACK message is lost, the completion message returns.	If the result by the completion message is needed, retransmit by updating the sequence number.
Completion message for the command	ERROR(Abnormality in the sequence number.)	Command has been performed.	If the result by the completion message is needed, retransmit by updating the sequence number.
Inquiry	Reply message	Inquiry is performed by retransmission.	Continue processing.
Reply message for the inquiry	ERROR(Abnormality in the sequence number.)	Inquiry has been performed.	If the result by the reply message is needed, retransmit by updating the sequence number.
Error message	Error message	Command is not performed. If the error cause eliminates, normal reply is return(ACK, reply message)	Eliminate the error cause. If normal reply returns, continue processing.
Inquiry of the VISCA device setting command	Reply message of the VISCA device setting command	Inquiry has been performed by retransmission.	Continue processing.
Reply message of the VISCA device setting command	ERROR(Abnormality in the sequence number.)	Inquiry has been performed.	If the result by the reply message is needed, retransmit by updating the sequence number.

VISCA over IP

Sequence chart as following

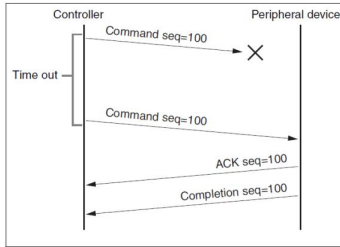

Sequence chart when command lost

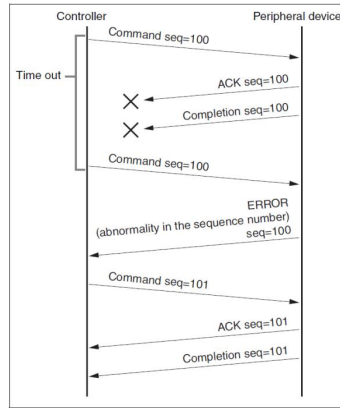

Sequence chart when returned message lost

Note: Do not set IP address, sub net mask, gateway parameter in VISCA over IP command, otherwise, it will cause network breaks off. Due to change these parameter, network will be in off status.



Telecam Technology Co.,Ltd

Add: 6F, Building A, Shuanghuan Information Technology Industrial Park, No.8, Baoqing Rd, Longgang District, Shenzhen, 518116, China

Tel: +86-755-33275155

Website: <https://www.telycam.com>

E-mail: telycam@telycam.com